

RackInBlack

Order form













ARCave GmbH
 Friedinger Strasse 2
 D-78224 Singen
 Tel. +49 7731 984296
 Fax +49 7731 984297
 info@arcave.de
 www.rundumwein.com
 www.weintempel.com



Order at your convenience by phone, fax, email or via our online shop on our website. We gladly provide you with 2D cellar visualisations free of charge.

Discount starting from EUR 750,00 - 3 %, from EUR 1'400,00 - 5 %, from EUR 2'500,00 - 8 %

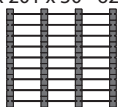
Packaging and delivery costs excluded in pricing. Conditions of payment: secure credit card payment online, wire transfer, payment 30 days net. Consult our website for further product information and assembly instructions. Our general terms and conditions set forth on our website apply.

RackInBlack shelf Art-No. 0541 bottles 12 	1.6 x 57 x 30 - 3 kg	pieces:	RackInBlack groupe Art-No. 8 bottles 96 	160 x 75 x 30 - 264 kg	pieces:	RackInBlack annex Art-No. A8 bottles 96 	160 x 66 x 30 - 144 kg	pieces:
RackInBlack column Art-No. 0540 	20 x 12 x 30 - 15 kg	pieces:	RackInBlack groupe Art-No. 16 bottles 192 	160 x 138 x 30 - 408 kg	pieces:	RackInBlack annex Art-No. A8 bottles 96 	160 x 66 x 30 - 144 kg	pieces:
SoftRack 75 bottle stopper Art-No. 0407 	3 x 50 x 20 - 60 g 2 Stk.	pieces:	RackInBlack groupe Art-No. 18 bottles 216 	180 x 138 x 30 - 459 kg	pieces:	RackInBlack annex Art-No. A9 bottles 108 	180 x 66 x 30 - 162 kg	pieces:
SoftRack 150 bottle stopper Art-No. 0408 bottles 1 Mag-Imp 	4 x 30 x 15 - 30 g 6 Stk.	pieces:	RackInBlack groupe Art-No. 27 bottles 324 	180 x 201 x 30 - 621 kg	pieces:	RackInBlack annex Art-No. A9 bottles 108 	180 x 66 x 30 - 162 kg	pieces:

Name/First name: _____ Phone: _____ Date: _____

Street: _____ Fax: _____

ZIP code/City: _____ E-Mail: _____ Signature: _____

Remarks: _____ Prices including 19 % (Germany) VAT

(hier abtrennen)

SANDYLINE TUFF

Order form



ARCave GmbH
 Friedinger Strasse 2
 D-78224 Singen
 Tel. +49 7731 984296
 Fax +49 7731 984297
 info@arcave.de
 www.aroundwine.com
 www.winetemple.com



Order at your convenience by phone, fax, email or via our online shop on our website. We gladly provide you with 2D cellar visualisations free of charge.

Discount starting from EUR 750,00 - 3 %, from EUR 1'400,00 - 5 %, from EUR 2'500,00 - 8 %

Packaging and delivery costs excluded in pricing. Conditions of payment: secure credit card payment online, wire transfer, payment 30 days net. Consult our website for further product information and assembly instructions. Our general terms and conditions set forth on our website apply.

SandyLine middle shelf Art-No. SL65 bottles 12-20 EUR 22,00	5 x 65 x 30 - 15 kg  including Sand	pieces:	SandyLine column Art-No. SLT2 EUR 13,65	20 x 11 x 30 - 9 kg 	pieces:	SandyLine group Art-No. B bottles 120-200 EUR 406,30	112 x 143 x 30 - 267 kg 	pieces:
SandyLine side shelf Art-No. SL71 bottles 12-20 EUR 22,00	5 x 71.5 x 30 - 15 kg  including Sand	pieces:	SandyLine top Art-No. SLT3 EUR 21,85	18 x 11 x 30 - 9 kg 	pieces:	SandyLine annex Art-No. BA bottles 60-100 EUR 172,10	112 x 65 x 30 - 114 kg 	pieces:
SandyLine individual shelf Art-No. SL78 bottles 12-20 EUR 22,00	5 x 78 x 30 - 15 kg  including Sand	pieces:	SandyLine slate plate Art-No. 0854 EUR 6,00	4 x 10 with Clip 	pieces:	SandyLine group Art-No. C bottles 144-240 EUR 491,25	137 x 143 x 30 - 324 kg 	pieces:
SandyLine base Art-No. SLT1 EUR 7,50	7 x 11 x 30 - 3 kg 	pieces:	SandyLine candleholder Art-No. SLTK EUR 17,85		pieces:	SandyLine annex Art-No. CA bottles 72-120 EUR 207,75	137 x 65 x 30 - 138 kg 	pieces:

Name/First name: _____ Phone: _____ Date: _____

Street: _____ Fax: _____

ZIP code/City: _____ E-Mail: _____ Signature: _____

Remarks: _____ Prices including 19 % (Germany) VAT

SANDYLINE KIT

Order form



ARCave GmbH
 Friedinger Strasse 2
 D-78224 Singen
 Tel. +49 7731 984296
 Fax +49 7731 984297
 info@arcave.de
 www.aroundwine.com
 www.winetemple.com



Order at your convenience by phone, fax, email or via our online shop on our website. We gladly provide you with 2D cellar visualisations free of charge.

Discount starting from EUR 750,00 - 3 %, from EUR 1'400,00 - 5 %, from EUR 2'500,00 - 8 %

Packaging and delivery costs excluded in pricing. Conditions of payment: secure credit card payment online, wire transfer, payment 30 days net. Consult our website for further product information and assembly instructions. Our general terms and conditions set forth on our website apply.

SandyLine middle shelf Art-No. SL65 bottles 12-20 EUR 22,00	5 x 65 x 30 - 15 kg  including Sand	pieces:	SandyLine column Art-No. SL02 bottles 2 EUR 15,50	26 x 13 x 30 - 12 kg 	pieces:	SandyLine group Art-No. F bottles 120-200 EUR 431,50	142 x 143 x 30 - 312 kg 	pieces:
SandyLine side shelf Art-No. SL71 bottles 12-20 EUR 22,00	5 x 71.5 x 30 - 15 kg  including Sand	pieces:	SandyLine top Art-No. SL03 EUR 33,00	25 x 13 x 30 - 18 kg 	pieces:	SandyLine group annex Art-No. FA bottles 60-100 EUR 180,50	142 x 65 x 30 - 129 kg 	pieces:
SandyLine individual shelf Art-No. SL78 bottles 12-20 EUR 22,00	5 x 78 x 30 - 15 kg  including Sand	pieces:	SandyLine slate plate Art-No. 0854 EUR 6,00	4 x 10 with Clip 	pieces:	SandyLine group Art-No. G bottles 144-240 EUR 522,00	173 x 143 x 30 - 378 kg 	pieces:
SandyLine base Art-No. SL01 bottles 1 EUR 8,50	13 x 13 x 30 - 6 kg 	pieces:	SandyLine candleholder Art-No. SL0K EUR 17,85		pieces:	SandyLine group annex Art-No. GA bottles 72-120 EUR 218,00	173 x 65 x 30 - 156 kg 	pieces:

Name/First name: _____ Phone: _____ Date: _____

Street: _____ Fax: _____

ZIP code/City: _____ E-Mail: _____ Signature: _____

Remarks: _____

Prices including 19 % (Germany) VAT

MULTI

Order form













ARCave GmbH
 Friedinger Strasse 2
 D-78224 Singen
 Tel. +49 7731 984296
 Fax +49 7731 984297
 info@arcave.de
 www.aroundwine.com
 www.winetemple.com

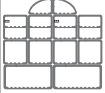

Order at your convenience by phone, fax, email or via our online shop on our website. We gladly provide you with 2D cellar visualisations free of charge.

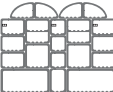
Discount starting from EUR 750,00 - 3 %, from EUR 1'400,00 - 5 %, from EUR 2'500,00 - 8 %

Packaging and delivery costs excluded in pricing. Conditions of payment: secure credit card payment online, wire transfer, payment 30 days net. Consult our website for further product information and assembly instructions. Our general terms and conditions set forth on our website apply.

Multi Profi Art-No. 0101 bottles 50-60 EUR 90,00	50 x 100 x 27 - 38 kg 	pieces:	Multi Kombi Art-No. 0105 bottles 12-16 EUR 40,00	50 x 33 x 27 - 15 kg 	pieces:	Multi group Art-No. 0129 bottles 370 EUR 820,00	183 x 200 x 27 - 316 kg 	pieces:
Multi Norm Art-No. 0102 bottles 24-30 EUR 58,00	50 x 50 x 27 - 20 kg 	pieces:	Multi Baby Art-No. 0106 bottles 6-9 EUR 27,00	33 x 33 x 27 -12 kg 	pieces:	Multi group Art-No. 0130 bottles 340 EUR 808,00	183 x 200 x 27 - 274 kg 	pieces:
Multi Tablar Art-No. 0103 bottles 16-24 EUR 69,00	50 x 50 x 27 - 22 kg 	pieces:	Multi Arc Art-No. 0107 bottles 9-11 EUR 60,00	33 x 50 x 27 - 15 kg 	pieces:	Multi group Art-No. 0131 bottles 380 EUR 1.035,00	183 x 233 x 27 - 361 kg 	pieces:
Multi Mini Art-No. 0104 bottles 12-16 EUR 40,00	33 x 50 x 27 - 15 kg 	pieces:	Multi Top Art-No. 0108 bottles 30 EUR 27,00	5 x 100 x ca. 27 - 11 kg 	pieces:	Multi group Art-No. 0132 bottles 500 EUR 1.073,00	183 x 250 x 27 - 381 kg 	pieces:

Name/First name: _____ Phone: _____ Date: _____

Street: _____ Fax: _____

ZIP code/City: _____ E-Mail: _____ Signature: _____

Remarks: _____ Prices including 19 % (Germany) VAT

IMPERIAL

Order form













ARCave GmbH
 Friedinger Strasse 2
 D-78224 Singen
 Tel. +49 7731 984296
 Fax +49 7731 984297
 info@arcave.de
 www.aroundwine.com
 www.winetemple.com



Order at your convenience by phone, fax, email or via our online shop on our website. We gladly provide you with 2D cellar visualisations free of charge.

Discount starting from EUR 750,00 - 3 %, from EUR 1'400,00 - 5 %, from EUR 2'500,00 - 8 %

Packaging and delivery costs excluded in pricing. Conditions of payment: secure credit card payment online, wire transfer, payment 30 days net. Consult our website for further product information and assembly instructions. Our general terms and conditions set forth on our website apply.

Imperial shelf Art-No. 0515 bottles 9-12 EUR 40,00	4 x 64 x 30 - 15 kg 	pieces:	softRack 75 bottle stopper Art-No. 0407 bottles 6-14 EUR 21,00	3 x 50 x 20 - 60 g 2 pieces 	pieces:	softRack 150 bottle stopper Art-No. 0408 bottle 1 Mag-Imp EUR 51,00	4 x 30 x 15 - 30 g  6 pieces	pieces:
Imperial column Art-No. 0514 EUR 16,40	20 x 8 x 30 - 9 kg 	pieces:	Imperial group Art-No. I-120 bottles 120 EUR 695,20	140 x 128 x 30 - 312 kg 	pieces:	Imperial annex Art-No. IA-60 bottles 60 EUR 299,00	140 x 64 x 30 - 129 kg 	pieces:
Imperial bottle stopper Art-No. 0406 EUR 12,30	2.5 x 5 x 20 white mamoreal 	pieces:	Imperial group Art-No. I-144 bottles 144 EUR 824,40	164 x 128 x 30 - 369 kg 	pieces:	Imperial annex Art-No. IA-72 bottles 72 EUR 355,50	164 x 64 x 30 - 153 kg 	pieces:
Imperial slate plate Art-No. 0858 EUR 6,00	4 x 10 - hook/loop tape 	pieces:	Imperial group Art-No. I-168 bottles 168 EUR 953,60	188 x 128 x 30 - 426 kg 	pieces:	Imperial annex Art-No. IA-84 bottles 84 EUR 412,00	188 x 64 x 30 - 177 kg 	pieces:

Name/First name: _____ Phone: _____ Date: _____

Street: _____ Fax: _____

ZIP code/City: _____ E-Mail: _____ Signature: _____

Remarks: _____

Prices including 19 % (Germany) VAT

CAVO

Order form











ARCAVE GmbH
 Friedinger Strasse 2
 D-78224 Singen
 Tel. +49 7731 984296
 Fax +49 7731 984297
 info@arcave.de
 www.aroundwine.com
 www.winetemple.com

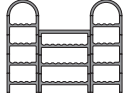
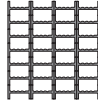

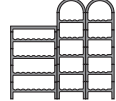
Order at your convenience by phone, fax, email or via our online shop on our website. We gladly provide you with 2D cellar visualisations free of charge.

Discount starting from EUR 750,00 - 3 %, from EUR 1'400,00 - 5 %, from EUR 2'500,00 - 8 %

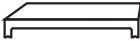
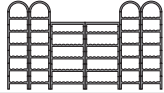
Packaging and delivery costs excluded in pricing. Conditions of payment: secure credit card payment online, wire transfer, payment 30 days net. Consult our website for further product information and assembly instructions. Our general terms and conditions set forth on our website apply.

Cavo 50 base 50 Art-No. 0303 bottles 12 EUR 23,00	29 x 50 x 27 - 20 kg 	pieces:	Cavo group Art-No. 0320 bottles 200 EUR 396,50	141/97 x 181 x 27 - 311 kg 	pieces:	Cavo group Art-No. 0329 bottles 340 EUR 644,00	203 x 200 x 27 - 560 kg 	pieces:
Cavo Arc cover 50 Art-No. 0305 EUR 35,00	25 x 50 x 27 - 16 kg 	pieces:	Cavo group Art-No. 0321 bottles 240 EUR 477,00	126/170 x 181 x 27 - 382 kg 	pieces:	Cavo group Art-No. 0330 bottles 350 EUR 561,00	213 x 162 x 27 - 490 kg 	pieces:
Cavo 81 base 81 Art-No. 0310 bottles 24 EUR 34,50	29 x 81 x 27 - 31.5 kg 	pieces:	Cavo group Art-No. 0327 bottles 380 EUR 819,00	199/170 x 250 x 27 - 640 kg 	pieces:	Cavo bottleneck-slate plate Art-No. 0852 EUR 4,80	8 x 8 	pieces:
Cavo cover 81 Art-No. 0311 EUR 39,00	10 x 81 x 27 - 24 kg 	pieces:	Cavo group Art-No. 0328 bottles 580 EUR 1.115,00	188 x 128 x 30 - 910 kg 	pieces:	Cavo small divider Art-No. 0111 EUR 11,60	divide into sections 	pieces:

Name/First name: _____ Phone: _____ Date: _____

Street: _____ Fax: _____

ZIP code/City: _____ E-Mail: _____ Signature: _____

Remarks: _____ Prices including 19 % (Germany) VAT

HYDROTON

Order form











ARCAve GmbH
 Friedinger Strasse 2
 D-78224 Singen
 Tel. +49 7731 984296
 Fax +49 7731 984297
 info@arcave.de
 www.aroundwine.com
 www.winetemple.com

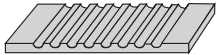

Order at your convenience by phone, fax, email or via our online shop on our website. We gladly provide you with 2D cellar visualisations free of charge.

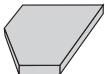
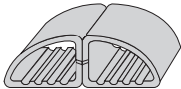
Discount starting from EUR 750,00 - 3 %, from EUR 1'400,00 - 5 %, from EUR 2'500,00 - 8 %

Packaging and delivery costs excluded in pricing. Conditions of payment: secure credit card payment online, wire transfer, payment 30 days net. Consult our website for further product information and assembly instructions. Our general terms and conditions set forth on our website apply.

HydroTon shelf T 60 Art-No. 0206 bottles 6-24 EUR 20,30	5 x 60 x 30 - 10 kg 	pieces:	HydroTon support S1 Art-No. 0201 bottles 1 EUR 8,50	13 x 13 x 30 - 6 kg 	pieces:	HydroTon group annex Art-No. g2 bottles 150 EUR 213,60	113 x 99 x 30 - 123 kg  annex g1	pieces:
HydroTon shelf T 90 Art-No. 0209 bottles 18-60 EUR 26,60	5 x 99 x 30 -14 kg 	pieces:	HydroTon support S2 Art-No. 0202 bottles 2 EUR 15,50	26 x 13 x 30 -12 kg 	pieces:	HydroTon group Art-No. g3 bottles 78 EUR 242,50	147 x 60 x 30 - 164 kg 	pieces:
HydroTon corner board Art-No. 0205 EUR 31,00	5 x 50 x 50 - 12 kg 	pieces:	HydroTon arc (pair) Art-No. 0211 bottles 18-22 EUR 120,00	33 x 99 x ca. 27 - 30 kg 	pieces:	HydroTon group annex Art-No. g4 bottles 69 EUR 172,00	147 x 60 x 30 - 107 kg  annex g3	pieces:
HydroTon base Art-No. 0210 EUR 4,50	5 x 10 x ca. 25 - 3 kg 	pieces:	HydroTon group Art-No. g1 bottles 156 EUR 267,60	113 x 99 x 30 - 162 kg 	pieces:	HydroTon group Art-No. g5 bottles 212 EUR 385,80	175 x 99 x 30 - 238 kg 	pieces:

Name/First name: _____ Phone: _____ Date: _____

Street: _____ Fax: _____

ZIP code/City: _____ E-Mail: _____ Signature: _____

Remarks: _____ Prices including 19 % (Germany) VAT

CAVINO

Order form















ARCave GmbH
 Friedinger Strasse 2
 D-78224 Singen
 Tel. +49 7731 984296
 Fax +49 7731 984297
 info@arcave.de
 www.aroundwine.com
 www.winetemple.com



Order at your convenience by phone, fax, email or via our online shop on our website. We gladly provide you with 2D cellar visualisations free of charge.

Discount starting from EUR 750,00 - 3 %, from EUR 1'400,00 - 5 %, from EUR 2'500,00 - 8 %

Packaging and delivery costs excluded in pricing. Conditions of payment: secure credit card payment online, wire transfer, payment 30 days net. Consult our website for further product information and assembly instructions. Our general terms and conditions set forth on our website apply.

Cavino 29 base Art-No. 0350 bottles 12 EUR 26,00	29 x 50 x 27 - 18 kg 	pieces:	Cavino group Art-No. 0366 bottles 200 EUR 453,00	164 x 150 x 27 - 312 kg 	pieces:	Cavino group Art-No. 0375 bottles 290 EUR 660,00	199/164 x 200 x 27 - 456 kg 	pieces:
Cavino 19 cover Art-No. 0360 bottles 6 EUR 21,00	19 x 50 x 27 - 14 kg 	pieces:	Cavino group Art-No. 0367 bottles 330 EUR 728,00	203 x 200 x 27 - 504 kg 	pieces:	Cavino group Art-No. 0373 bottles 490 EUR 1,112,00	170/135 x 400 x 27 - 768 kg 	pieces:
Cavino B arc Art-No. 0355 bottles 8 EUR 23,00	25 x 50 x 27 - 16 kg 	pieces:	Cavino group Art-No. 0368 bottles 300 EUR 708,00	193 x 200 x 27 - 488 kg 	pieces:	Cavino slate plate Art-No. 0850 EUR 4,50	4 x 10 	pieces:
Cavino group Art-No. 0365 bottles 100 EUR 250,00	135 x 100 x 27 - 172 kg 	pieces:	Cavino group Art-No. 0374 bottles 200 EUR 485,00	170/199 x 150 x 27 - 336 kg 	pieces:	Cavino small divider Art-No. 0111 EUR 11,60	divide into sections 	pieces:

Name/First name: _____ Phone: _____ Date: _____

Street: _____ Fax: _____

ZIP code/City: _____ E-Mail: _____ Signature: _____

Remarks: _____ Prices including 19 % (Germany) VAT

BURGUNDY RACK

Order form

ARCave GmbH
 Friedinger Strasse 2
 D-78224 Singen
 Tel. +49 7731 984296
 Fax +49 7731 984297
 info@arcave.de
 www.aroundwine.com
 www.winetemple.com



Order at your convenience by phone, fax, email or via our online shop on our website. We gladly provide you with 2D cellar visualisations free of charge.

Discount starting from EUR 750,00 - 3 %, from EUR 1'400,00 - 5 %, from EUR 2'500,00 - 8 %

Packaging and delivery costs excluded in pricing. Conditions of payment: secure credit card payment online, wire transfer, payment 30 days net. Consult our website for further product information and assembly instructions. Our general terms and conditions set forth on our website apply.

BurgundyRack Art-No. 0558 1 OWC 12 btls. EUR 158,00	25 x 60 x 36 - 8.6 kg 	pieces:	softRack 75 bottle stopper Art-No. 0407 bottles 6-14 EUR 21,00 2 pieces par unit	3 x 50 x 20 - 60 g 	pieces:
BurgundyRack base only one pair per tower required Art-No. 0559 EUR 48,00	3 x 60 x 10 - 4 kg 	pieces:	softRack 150 bottle stopper Art-No. 0408 for Magnum to Imperial formate EUR 51,00 6 pieces par unit	4 x 30 x 15 - 30 g 	pieces:

Much more than a simple Burgundy case Rack

In addition to 6 and 12 bottle Burgundy cases, you can store your Imperial and oversized Bordeaux cases with ease. Outstanding quality and craftsmanship can be seen and felt in every detail of the rack. And thanks to the innovative snap on concept no tools are required for assembly.

Name/First name: _____ Phone: _____ Date: _____

Street: _____ Fax: _____

ZIP code/City: _____ E-Mail: _____ Signature: _____

Remarks: _____ Prices including 19 % (Germany) VAT

Inline Order form









ARCave GmbH
Friedinger Strasse 2
D-78224 Singen
Tel. +7731 984296
Fax +7731 984297
info@arcave.de
www.aroundwine.com
www.winetemple.com

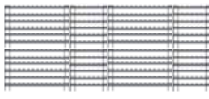

Order at your convenience by phone, fax, email or via our online shop on our website. We gladly provide you with 2D cellar visualisations free of charge.

Discount starting from EUR 750,00 - 3 %, from EUR 1'400,00 - 5 %, from EUR 2'500,00 - 8 %

Packaging and delivery costs excluded in pricing. Conditions of payment: secure credit card payment online, wire transfer, payment 30 days net. Consult our website for further product information and assembly instructions. Our general terms and conditions set forth on our website apply.

<p>Inline Series6 Art-No. 0580 bottles 156 x 75cl</p>  <p>EUR 250,00</p>	<p>81.5 x 30 x 73 - 23 kg</p> <p>pieces:</p>	<p>Inline group Art-No. 0584 btls. 432</p>  <p>EUR 1.660,00</p>	<p>163 x 30 x 322 - 160 kg</p> <p>pieces:</p>
<p>Inline Series12 Art-No. 0581 btls. 84</p>  <p>EUR 290,00</p>	<p>81.5 x 30 x 124.5 - 28 kg</p> <p>pieces:</p>	<p>Inline group Art-No. 0585 btls. 528</p>  <p>EUR 2.160,00</p>	<p>163 x 30 x 395 - 206 kg</p> <p>pieces:</p>
<p>Inline group Art-No. 0582 btls. 132</p>  <p>EUR 540,00</p>	<p>81.5 x 30 x 197.5 - 52 kg</p> <p>pieces:</p>	<p>Inline group Art-No. 0586 btls. 660</p>  <p>EUR 2.700,00</p>	<p>203.75 x 30 x 395 - 258 kg</p> <p>pieces:</p>
<p>Inline group Art-No. 0583 btls. 264</p>  <p>EUR 1.080,00</p>	<p>163 x 30 x 197.5 - 103 kg</p> <p>pieces:</p>	<p>Inline magnetic label Art-No. 0855</p>  <p>EUR 4,50</p>	<p>1.5 cm x 10 cm</p> <p>pieces:</p>



no tools required
pieces simply fit together
lightweight, modern



Name/First name: _____ Phone: _____ Date: _____

Street: _____ Fax: _____

ZIP code/City: _____ E-Mail: _____ Signature: _____

Remarks: _____ Prices including 19 % (Germany) VAT

COLLECTION - RACK

Order form



ARCave GmbH
 Friedinger Strasse 2
 D-78224 Singen
 Tel. +49 7731 984296
 Fax +49 7731 984297
 info@arcave.de
 www.aroundwine.com
 www.winetemple.com



Order at your convenience by phone, fax, email or via our online shop on our website. We gladly provide you with 2D cellar visualisations free of charge.

Discount starting from EUR 750,00 - 3 %, from EUR 1'400,00 - 5 %, from EUR 2'500,00 - 8 %

Packaging and delivery costs excluded in pricing. Conditions of payment: secure credit card payment online, wire transfer, payment 30 days net. Consult our website for further product information and assembly instructions. Our general terms and conditions set forth on our website apply.

CollectionRack BordeauxRack Art-No. 0555 btls. 12 oder 2 x 6 EUR 92,00 	22.5 x 38 x 51 - 6.7 kg	pieces:	CollectionRack base single Art-No. 0556 EUR 33,90 	3 x 38 x 10 - 4 kg	pieces:	CollectionRack Top-slate Art-No. 0856 EUR 155,00 	1.5 x 38 x 51 - ca. 7.5 kg	pieces:
CollectionRack CR75 Art-No. 0551-75 btls. 12 x 75cl EUR 122,00 	22.5 x 38 x 51 - 8.6 kg	pieces:	CollectionRack base double Art-No. 0557 EUR 49,00 	3 x 76 x 10 - 4.5 kg	pieces:	SoftRack 75 bottle stopper Art-No. 0407 bottles 6-14 EUR 21,00 	3 x 50 x 20 - 60 g	pieces:
CollectionRack CR150 Art-No. 0551-150 btls. 6 x Magnum EUR 122,00 	22.5 x 38 x 51 - 8.6 kg	pieces:	CollectionRack TopRack- Magnum Art-No. 0554 bot. 3 Magnum EUR 49,00 	17 x 38 x 51 - 4 kg	pieces:	softRack 150 bottle stopper Art-No. 0408 Magnum-Imperial EUR 51,00 	4 x 30 x 15 - 30 g	pieces:
CollectionRack CR375 Art-No. 0551-375 btls. 20 x 375cl EUR 122,00 	22.5 x 38 x 51 - 8.6 kg	pieces:	CollectionRack TopRack double Art-No. 0553 bot. 8 x 75cl EUR 74,00 	17 x 38 x 51 - 4 kg	pieces:	CollectionRack magnetic label Art-No. 0855 EUR 3,40 	1.5 x 10	pieces:

Name/First name: _____ Phone: _____ Date: _____

Street: _____ Fax: _____

ZIP code/City: _____ E-Mail: _____ Signature: _____

Remarks: _____ Prices including 19 % (Germany) VAT

COLLECTION-RACK 90

Order form







ARCave GmbH
 Friedinger Strasse 2
 D-78224 Singen
 Tel. +49 7731 984296
 Fax +49 7731 984297
 info@arcave.de
 www.aroundwine.com
 www.winetemple.com



Order at your convenience by phone, fax, email or via our online shop on our website. We gladly provide you with 2D cellar visualisations free of charge.

Discount starting from EUR 750,00 - 3 %, from EUR 1'400,00 - 5 %, from EUR 2'500,00 - 8 %

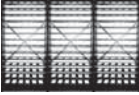
Packaging and delivery costs excluded in pricing. Conditions of payment: secure credit card payment online, wire transfer, payment 30 days net. Consult our website for further product information and assembly instructions. Our general terms and conditions set forth on our website apply.

CollectionRack CR90 Art-No. 0551 bottles 90 EUR 885,00	148 x 67 x 35 - 35 kg 	pieces:	CollectionRack CR90 group Art-No. CR290 bottles 180 EUR 1.770,00	148 x 134 x 35 - 70 kg 	pieces:
			CollectionRack CR90 group Art-No. CR390 bottles 270 EUR 2.655,00	148 x 201 x 35 - 105 kg 	pieces:
			CollectionRack magnetic label Art-No. 0857 EUR 3,40	marking of the storage rack 2.5 x 11.5 	pieces:
			CollectionRack magnetic label Art-No. 0855 EUR 3,40	marking of the drawers 1.5 x 10 	pieces:

Name/First name: _____ Phone: _____ Date: _____

Street: _____ Fax: _____

ZIP code/City: _____ E-Mail: _____ Signature: _____

Remarks: _____ Prices including 19 % (Germany) VAT

VARIORACK

Order form

ARCave GmbH
 Friedinger Strasse 2
 D-78224 Singen
 Tel. +49 7731 984296
 Fax +49 7731 984297
 info@arcave.de
 www.aroundwine.com
 www.winetemple.com



Order at your convenience by phone, fax, email or via our online shop on our website. We gladly provide you with 2D cellar visualisations free of charge.

Discount starting from EUR 750,00 - 3 %, from EUR 1'400,00 - 5 %, from EUR 2'500,00 - 8 %

Packaging and delivery costs excluded in pricing. Conditions of payment: secure credit card payment online, wire transfer, payment 30 days net. Consult our website for further product information and assembly instructions. Our general terms and conditions set forth on our website apply.

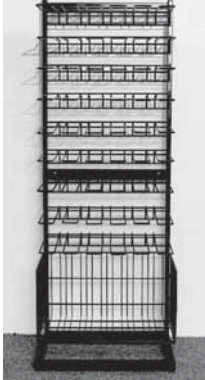
VarioRack Art-No. 0570 bottles 78 x 75cl EUR 560,00  Contains: basic frame, adjustable feet, 9 bottle shelves, 1 basket	150 x 56 x 36 - 28 kg	pieces:	VarioRack magnetic label Art-No. 0857 EUR 3,40	2.5 x 11.5	pieces:	VarioRack group 2 Art-No. 0570-2 bottles 156 x 75cl EUR 1.120,00	150 x 112 x 36 - 56 kg	pieces:
			VarioRack label Art-No. 0568 EUR 0,80	4.5 x 4.5	pieces:	VarioRack group 3 Art-No. 0570-3 bottles 234 x 75cl EUR 1.680,00	150 x 168 x 36 - 84 kg	pieces:
			softRack 75 bottle stopper Art-No. 0407 bottles 6-14 EUR 21,00	3 x 50 x 20 - 60 g 2 pieces	pieces:	VarioRack group 4 Art-No. 0570-4 bottles 312 x 75cl EUR 2.240,00	150 x 224 x 36 - 112 kg	pieces:
				Find further useful accessories around wine at our online-shop www.aroundwine.com				

Name/First name: _____ Phone: _____ Date: _____

Street: _____ Fax: _____

ZIP code/City: _____ E-Mail: _____ Signature: _____

Remarks: _____

Prices including 19 % (Germany) VAT